

Installation Guide for Portable Series X-Press Screen

Liberty Grandview®

AV-VISION
EQUIPMENTS (INDIA) (P) LTD.

Mktg. Off: 1-20-248, 2nd Floor, (Snowcem Paints Lane),
Rasoolpura, Secunderabad-500 003, A.P., INDIA.
Tel : +91(0)40-2781 5419 / 2781 4350 / 2789 0599 / 2781 8419 / 20 / 21
Fax : +91(0)40-2781 5399 (Off.) / 2781 4612 (Mktg)
Mobile: + 91- (0) 99590 24099 / 98490 24099
E-mail : sales@av-visionindia.co.in
Website : www.av-visionindia.co.in

Grandview Crystal Screen Canada Ltd.

#11- 3751 North Fraser Way,
Marine Way Business Centre,
Burnaby, BC, Canada V5J 5G4
Tel: 1-604-412-9777 Fax: 1-604-412-9796
Website: www.grandviewscreen.ca

Guangzhou Grandview Crystal Screen Co., Ltd.

No.43 South International Trade Avenue, Hualong Town,
Panyu, Guangzhou, Guangdong, China
Tel: +8620-8489-9499 Fax: +8620-8480-3343
Website: www.grandviewscreen.com
www.grandviewscreen.com.cn



Model: CB-UXxx

Thank you for purchasing a Liberty Grandview projection screen.
Before use, please read instructions carefully. After installation, store instructions for future reference.

Description

Illustration

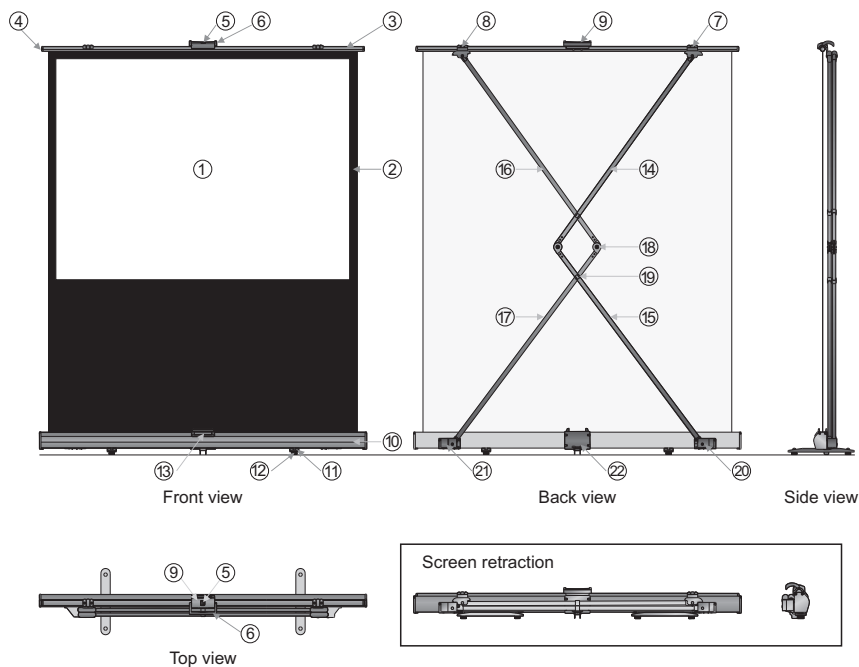

Part name

①	Fabric	⑫	Foot wheel
②	Fabric black border	⑬	Front base
③	Semicircle tube	⑭	Support lever
④	Rod	⑮	Support lever
⑤	Tube lock	⑯	Support lever
⑥	Handle	⑰	Support lever
⑦	Left bracket	⑱	Support lever joint
⑧	Right bracket	⑲	Support lever pipe
⑨	Handle base	⑳	Seat
⑩	Casing	㉑	Seat
⑪	Foot	㉒	Rear base

Warning

1. Don't expose the screen in wind.
2. For the flatness of the fabric, remember:
 - a) Don't touch the screen surface with hands.
 - b) Don't write or draw on the screen surface.
 - c) Don't poke screen fabric with finger or edge tools.
 - d) Clean the fabric with soft cloth and lukewarm water. Don't use any detergent or any diluent cleanser.
3. Lift up and retract the screen with even speed and force.
4. Retract fabric into the casing after display.
5. When retracting the screen, make sure the support lever joint is fastened into the support lever pipe.
6. Make sure the handle base is fastened and locked before carry.
7. In case of damage, the screen is recommended to be managed and operated by adults.



Ignoring the safety warnings may lead to injuries and/or damaging the product.



Retract the screen after every use. Leave it hanging for a long period may cause screen fabric loose



Avoid hanging anything on the screen as it may cause the screen to fall down.



Please contact your local dealer for repairs or maintenance. Please contact our company if you have any further questions. Avoid taking apart the fixtures yourself. Loose parts may cause the screen to fall.

Do not take apart and replace with unknown parts. If there are any problems, please contact your local dealer. Product specifications are subject to change.

Specifications

Format	Model	Specification (In)	Viewing area		Screen dimension		B1 (mm)	Net weight (kg)
			W (mm)	H (mm)	L (mm)	A (mm)		
4:3	CB-U70	70"	1422	1067	1582	2400	35	
	CB-U80	80"	1625	1220	1785	2553	35	
16:9	CB-U70	70"	1550	871	1710	2204	35	
	CB-U80	80"	1770	995	1916	2328	28	

Note: Sizes and specifications are subject to change at any time. Refer to real product for exact data.
The tolerance for L is ± 5 mm.

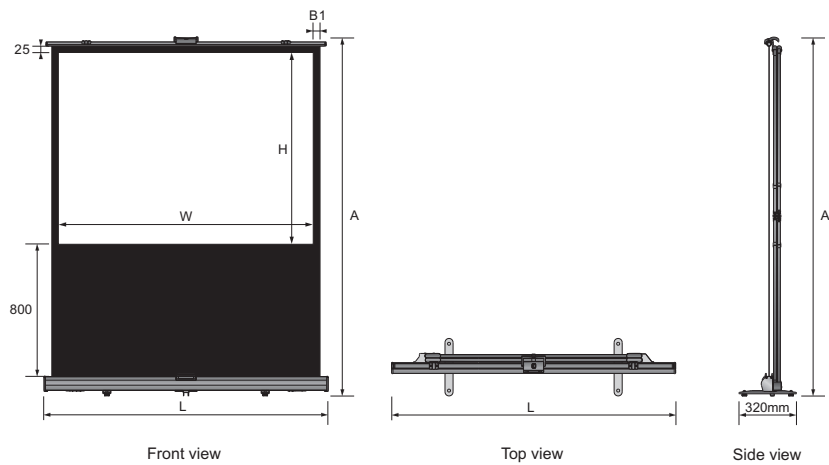

Measurement unit: mm

Open Screen

- Put the screen on the ground, in a proper position facing the projector. Turn the feet out until they are perpendicular to the screen casing (Figure 1 - 3).

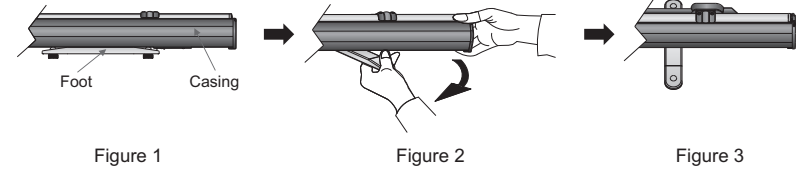

- Pull up the handle as the arrow indicates below (Figure 4 - 5).

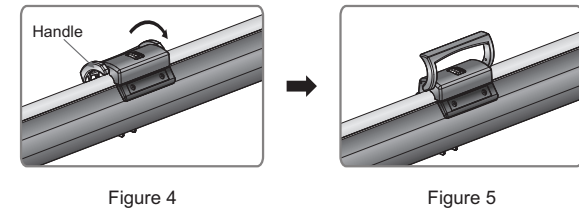

- Pull up the handle while using the thumb to release the tube lock as arrow indicates (Figure 6).

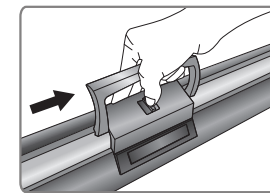

Figure 6

Retract screen

4. Pull up the screen with constant speed and stop at desired position for three minutes so that the screen can be installed (Figure 7 - 10).

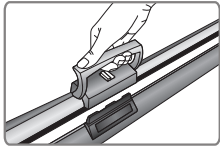

Figure 7

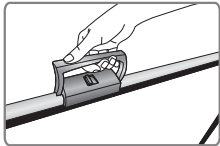

Figure 8

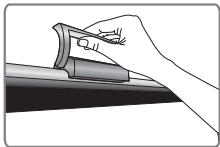

Figure 9

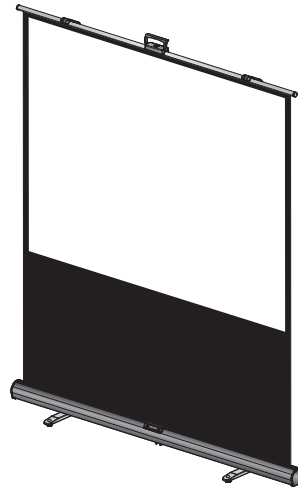

Figure 10

5. Adjust the foot wheel when the ground is not even. To be exact, clockwise rotation raises the foot while counterclockwise rotation lowers the foot, with limits of five circles or within 8mm (Figure 11 - 12).

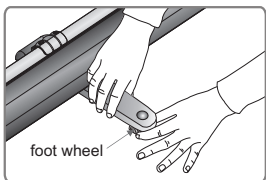

Figure 11

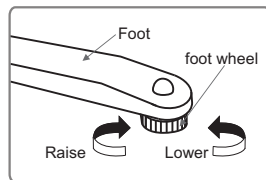

Figure 12

1. Grasp the handle and retract the screen into the casing till the handle base is firmly fastened in the tube lock (Figure 13 - 15).

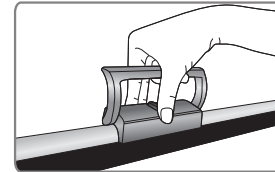

Figure 13

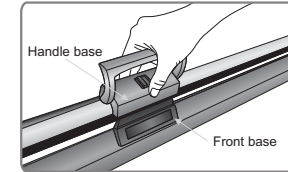

Figure 14

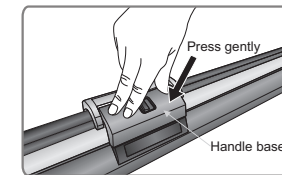

Figure 15

2. Rotate the feet in line with the casing. Retraction is completed (Figure 16 - 18).

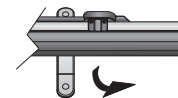

Figure 16

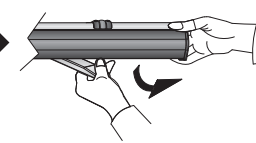

Figure 17

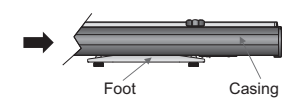

Figure 18